

GB Fitting Instruction for Accessory

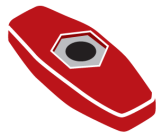

x 4

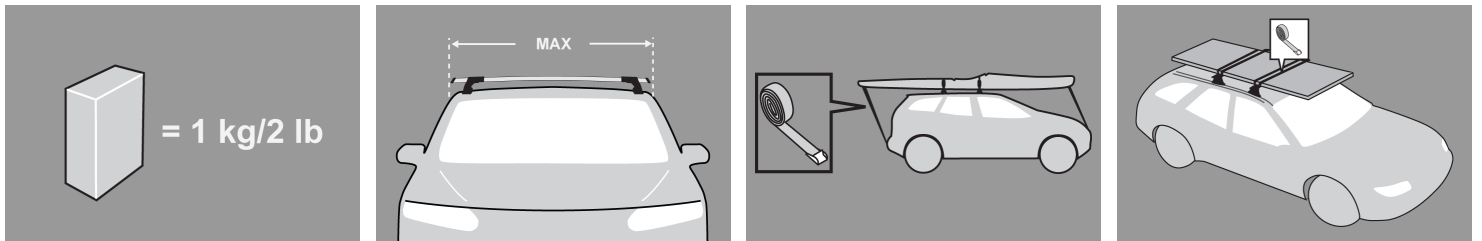
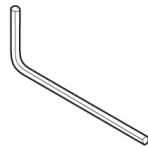

x 1

3 mm

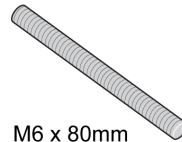

x 4

M6 x 80mm



x 4

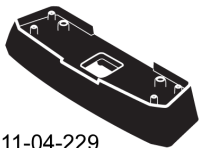

x 2

11-04-229

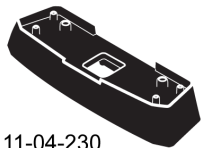

x 2

11-04-230



MAX kgs

🚩 **W/P WHD**

MAX kgs

🚩 **W/P WHD**

BMW

5 Series Gran Turismo, 4dr Sedan 09-+	ZA	75	75	5 Series Gran Turismo, 4dr Sedan 09-+	US	75	75
5 Series Gran Turismo, 4dr Sedan 09-+	EU	75	75	5 Series Gran Turismo, 4dr Sedan 09-+	NZ	75	75
5 Series Gran Turismo, 4dr Sedan 09-+	AU	75	75				

First Time Installation



- Remove parts from inside the package and check. Contact your dealer if any parts are missing or damaged.



- These instructions show type A crossbar fitted. They also apply to type B, C and D.
- This kit fits type A, B, C and D.



- Use keys to remove covers.



- Use hex screwdriver to reverse adjusting screw 10 turns.



- Press adjusting screw and pull crossbar legs out. Refer to the crossbar instructions for crossbar adjustment.
- Ensure each end of the crossbar is adjusted equally.

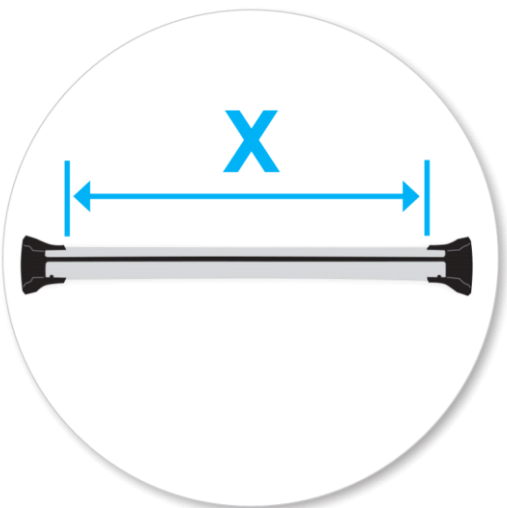

- Attaches to factory-fitted mounting points
- Please check the rear of this manual for information relating specifically to your vehicle.
- Adjust crossbar in or out to suit vehicle. Refer to the crossbar instructions for crossbar adjustment.



- Tighten adjusting screw to 5 Nm (3.7 ft lb).



- Remove plastic clamp block by gripping bar leg with fingers and push firmly with thumbs until clamp block drops out behind leg.



- Select plastic internal block (from fitting kit) and insert into foot.
- Repeat for all legs.

Fitment



- Open or remove fixed-point covers.

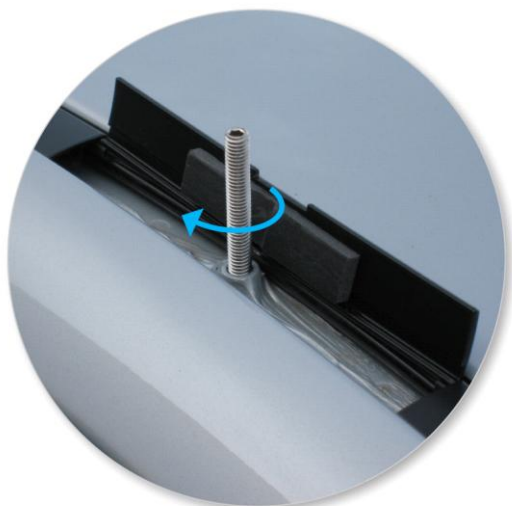

- Select grubscrews and screw into the vehicle's fixed points.
- Do not over tighten.
- Repeat for all four positions.



- Refer to the underside of the pad for the part number.

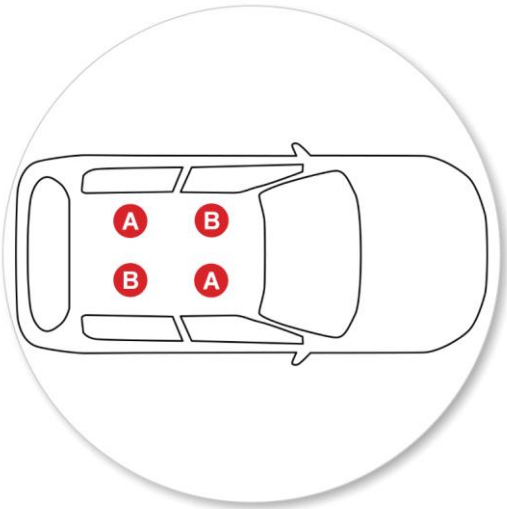

- Letters refer to the pad part numbers and position.
- Pad Part Number:
A = 11-04-229
B = 11-04-230
- It is important to put the pads in the correct position on the vehicle.



- Ensure the fixed-point covers sit vertically in the recess in the pads.



- Place crossbars on pads ensuring the pads fit into the holes underneath the foot and the grub screw pass through the hole in the foot.
- Repeat for all four positions.



- Tighten the red plastic knob. The side with the nut showing should be facing up.



- Ensure the red plastic knob is in the position shown when fully tightened.
- Repeat for all legs.



- Check crossbar is securely attached to the vehicle.
- Use keys to fit and lock covers

CAUTION:

Recheck all fasteners immediately after a load is applied to the crossbars.

Regularly check screws are tight.

Maintenance

- Clean the car roof and surfaces of the product that will be in contact with the car roof.
- Follow the fitting instructions for fitting the product to your vehicle. Make sure all steps are carried out in order.
- Set crossbars a minimum distance of 700mm (27 1/2") apart where no other distance is specified in the fitting instructions. This is especially important when carrying long loads.
- Check unit is securely attached whenever you refit it to the vehicle. If the unit feels loose, refer to the fitting instructions and readjust.
- Some glass/panoramic roofs and radio antennae may not be able to be used when the product is fitted.
- Do not modify this product.
- Refer to the maximum permitted load capacity specified in the fitting instructions. Do not exceed the vehicle manufacturers roof load rating if it is lower than the maximum load capacity specified in the fitting instructions.
- Loads should not overhang the sides of the product and be evenly distributed with the lowest possible centre of gravity.
- Long loads should be secured with non-elastic straps to the front and rear of the vehicle.
- Objects with pointed ends (e.g. ski poles) should be carried with the pointed ends to the rear of the vehicle.
- Remove all loose or removable objects from the load prior to loading.
- Make sure all loads are securely fastened with non-elastic straps. Check regularly during longer journeys.

- A loaded roof rack system can alter the performance of your vehicle. Be especially aware of the effects of side winds, changing of direction, and braking performance. Avoid rapid acceleration and deceleration. Drive carefully.
- Note that the total height of the vehicle increases when upright loads are carried.
- Products should be locked during transport if they have locks fitted.
- Check and replace worn out or defective parts.
- Keep the product clean and maintained.
- Never drive into a car wash with the roof rack system fitted.
- Lubricate locks and adjusting screws at regular intervals.
- Remove the products from the vehicle when not in use. Make sure all loose parts are stored safely.

-
- Hubco Automotive Ltd
P. O. Box 11017
Christchurch
NEW ZEALAND

www.whispbar.com
www.whispbar.com.au
www.whispbar.co.nz
www.whispbar.co.uk
www.whispbar.co.za
www.whispbar.eu
www.whispbar.ca

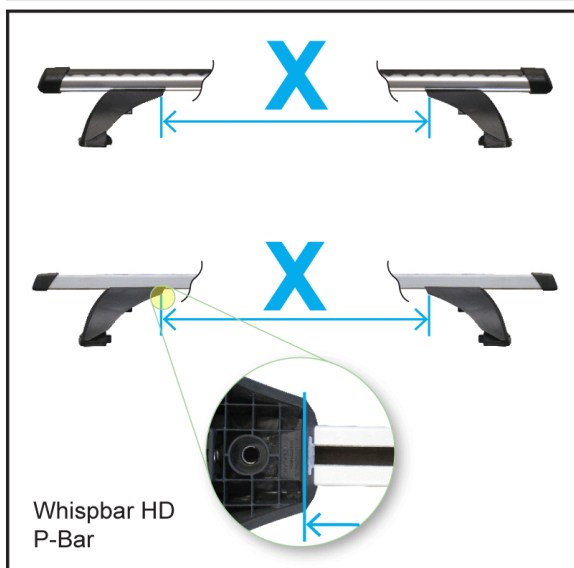
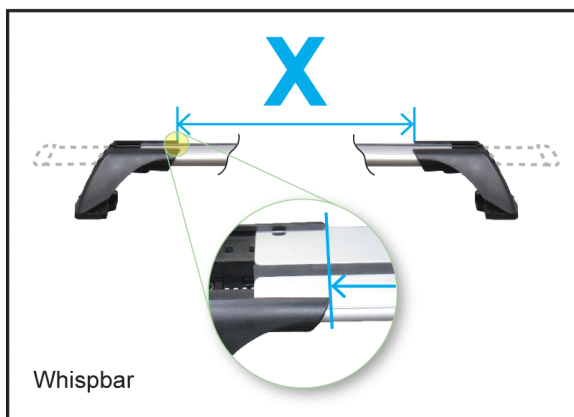
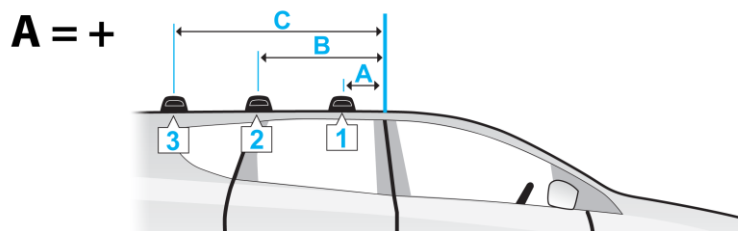
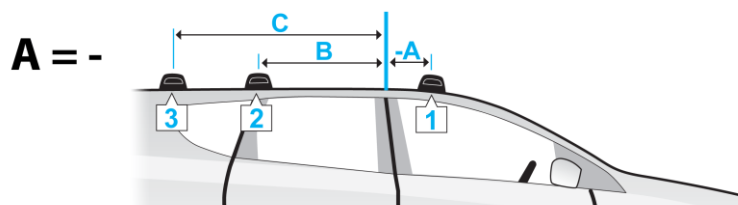

	A	B	C	X		
				1	2	3
BMW 5 Series Gran Turismo, 4dr Sedan 09+ (AU)	-270mm -10 5/8"	430mm 16 15/16ths"	-	1065mm 41 15/16ths"	1065mm 41 15/16ths"	-
BMW 5 Series Gran Turismo, 4dr Sedan 09+ (EU)	-270mm -10 5/8"	430mm 16 15/16ths"	-	1065mm 41 15/16ths"	1065mm 41 15/16ths"	-
BMW 5 Series Gran Turismo, 4dr Sedan 09+ (NZ)	-270mm -10 5/8"	430mm 16 15/16ths"	-	1065mm 41 15/16ths"	1065mm 41 15/16ths"	-
BMW 5 Series Gran Turismo, 4dr Sedan 09+ (US)	-270mm -10 5/8"	430mm 16 15/16ths"	-	1065mm 41 15/16ths"	1065mm 41 15/16ths"	-
BMW 5 Series Gran Turismo, 4dr Sedan 09+ (ZA)	-270mm -10 5/8"	430mm 16 15/16ths"	-	1065mm 41 15/16ths"	1065mm 41 15/16ths"	-